

**KORNICHE**

**Korniche  
bi-fold doors  
transform  
your space**





Multi-Award-Winning



# it's our mission to achieve your vision

Korniche was founded with the mission to bring inspirational products to light through innovative design and engineering. The Korniche Lantern was the first of its kind, a dedicated product designed from a clean sheet, using ground-breaking new technologies rather than just being another version of a conservatory roof system. The same methodology has been followed with the equally innovative Korniche bi-folding door and flat glass.

Since launch these multi-award winning products have been embraced by homeowners and builders alike, and our vision is to become the first brand you go to for smarter, better engineered and inspirational glazed products.

All Korniche products are made from thermally broken and powder coated aluminium. This great looking premium material means stronger products with tighter tolerances,

superb weather resistance, high thermal performance, and minimal maintenance.

All Korniche products are manufactured exclusively by us. This means you benefit from investment in the latest fabrication methods, a clear focus on engineering excellence and industry leading quality controls, Korniche products are consistently delivered to an extremely high standard.



# a brighter home

with smarter engineering.

Brighten and expand your home with industry-leading bi-folding doors from Korniche. Combine smart engineering with inspirational design to blur the lines between outside and in.

## Outside, Inside

The Korniche bi-folding door makes it easy to elevate the design of any build or renovation project. Large sections of glass in a design brings in light and makes a room feel like it is actually expanding into your outside space. Using a bifold door gives the added advantage of being able to entirely open the room up, making the environment as one.

Getting that all important natural light into an interior space creates ambience, enhancing your decor whilst energising and improving your well-being.

## Precision Engineering

At Korniche we are driven by perfection, and we understand that there is no such thing as compromise when it comes to your dream home and that should be reflected in the products you choose.

That's why a Korniche product is designed entirely in house and from the ground up. We go to great lengths to ensure every component has been engineered to combine and complement with the next – we minimise use of third party hardware and we never use third party manufacture.

When you buy Korniche, you can rest assured that the attention to detail we designed into the product is carried all the way through to the end product.







## **SPEED**BEAD

The unique patented SpeedBead, a secret ingredient allowing Korniche bi-fold doors to be glazed in seconds, along with a neat groove design allowing the seals to be hidden within the frame..

# all in the detail

Korniche products are known to be stronger, slimmer, warmer and faster to install. This is achieved by a focus on small but unique features which improve heat retention, security, function, aesthetic appeal and It's this attention to little details that makes the difference.

Great looking handles in matching finishes. The perfect glide. Slimmer profiles. More glass. Better protection. Superb heat retention. Easy, consistent installation.

## Slim Strong Stylish

Aluminium profiles are all professionally powder coated at point of manufacture in colours as subtle or as vivid as your vision requires. Regardless of whether they are stock or bespoke the very high quality is always the same.

Our unique Patented SpeedBead, the secret ingredient which allows the doors to be glazed in seconds, also comes with a neat groove design allowing the seals to be hidden within the frame, meaning a slimmer sight-line between glass units, maximising light and views.

Even our bespoke handles were designed in house to suite together perfectly and match the design features of the door. All the hardware comes from the same factory ensuring perfectly matching finishes.

It's these small but essential details that set Korniche products apart.



Where profiles are thermally broken and structural polyamide sections are fitted to provide insulation between external and internal faces, we always install them after each half has been powder coated. This ensures stark black lines create a smart contrast between the two elements with no over spray.

# engineered for **everyday**

Make a more  
memorable entrance time  
and time again

Expertly engineered, Korniche bi-folding doors exude the same quality in their function as they do in their design, where a fine eye for detail delivers an effortlessly smooth user experience every time.

Load bearing guides use spherical bearings to allow a pivoting motion in the main axle. This unique design allows the guide wheels to absorb any misalignment in the stainless-steel tracks underneath, preventing premature wear and tight spots. Combining this design with fully sealed bearings in the stainless-steel wheels and rollers keep doors gliding effortlessly for years to come.

High-quality bespoke hardware with premium finishes ensures your door handles maintain their great appearance during day-to-day operation. Behind the coatings the ergonomics have been carefully considered for all the touch points, starting out with the feel of components in your hand and extending to limiting the degrees of rotation in the shootbolt handles for more comfort in use.

Sometimes you want to  
keep the outside out

When it comes to locks and security we have opted to use a proven Yale locking barrel at the heart of a precision engineered multi-point locking system. The final touch is our fully lockable Korniche shoot-bolt which can't be opened from the outside even when unlocked thanks to anti-backdrive technology.

Korniche bifold doors are PAS 24 as standard and can be specified to be Document Q compliant when fitted with laminated glass.

Keeping control of the temperature in your home is vital, especially during the winter. Our aluminium frame parts have deep polyamide thermal breaks which keep outer and inner parts thermally isolated from each other minimising heat transfer. Bespoke designed seals complete the picture protecting the system against air and water ingress. Our bi-folding doors are designed to keep heat in and the weather out.







Expertly engineered, Korniche bi-folding doors exude the same quality in their function as they do in their design, where a fine eye for detail delivers an effortlessly smooth user experience every time.



MULLION BOTTOM ROLLER



LOWER ROLLER HINGE



UPPER GUIDE HINGE

# bespoke options come as standard



## Our award-winning product, tailored to you

Creating stunning panoramic views for your home, our bi-folding doors have been engineered with versatility in mind. Korniche bi-folding doors can be fabricated in any number of configurations from a single to a seven-door system catering for openings of any size.

Once you've chosen a configuration, choose from our range of standard or bespoke colours. Our powder coated finishes don't just offer a wide range of colours, the tough, durable, polymer coat has a very high resistance to discolouration and wear and tear, ensuring you can expect easy maintenance over the long life of the product.

Glazing is available with toughened (as standard) or laminated options. Integrated blinds are available with either option and are detailed in the next section.

A range of hardware options complete the look of your product before you, or your chosen installer, moves into the more technical selections where Korniche still offers market leading choice.

Choose from the neat integrated cill threshold or our standard threshold with or without a cill. Regardless, every configuration has a fully sealing rebate meaning even our lowest height integrated cill option comes with the same weather rating as the standard frame. Frame options are available to allow internal floors to be level and the installation position adjusted to reduce step-over to a minimum.

Finally choose whether or not the door requires trickle ventilation.

## Colours

Profile is available in standard stock or bespoke colours

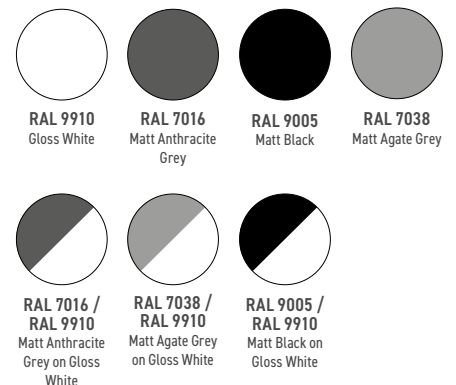

We offer more than 150 colours in matt, satin or gloss, including the option to have different colours on the inside and outside of the frames. This gives you total freedom to match both the interior and exterior style of your property. Bespoke colours add approx. 5 weeks to lead time.



## Options

Traffic door and shootbolt handles are available in finishes of black, white, grey, polished chrome or brushed stainless steel. Dual colour options available

- 100mm, 150mm or 190mm cill options
- Standard or integrated cill thresholds
- Trickle vents can be installed directly into the head of your door, removing the need for a frame extender they are available in black, anthracite grey, agate grey, white or dual colour, and deliver 2667mm<sup>2</sup> of airflow per vent
- 20mm or 40mm frame extender profiles if required

## Traffic door handles





# a smarter home innovation built-in

Uni-Blinds®

## SLIDING VENETIAN INTEGRAL BLINDS

SL20SV Sliding Control Uni-Blinds available for your Korniche Bi-folding Door. Integrated venetian blind providing a smart solution with ingenious slider control for all the blind function in one easy to use device.

### Cordless Control

Based on the technically proficient Screenline integral blind system from globally renowned manufacturer Pellini, the SL20SV provides a slick visual result with no cords on the face of the glass. Like all Screenline blinds, the SL20SV sliding system represents **the highest quality and operational reliability of any integral blinds.**

The blind is encapsulated within the two glass panes of a double glazed unit, **the thermal efficiency is optimised thanks to a warm edge spacer bar as standard.**

### SV System Benefits

Closed-loop belt transmission system allows smooth and long-lasting function of the blind.

External magnetic slider is treated with a patented antibacterial finish, providing a long-lasting protective function against viruses.













Fully compliant with child safety standards.

Requires only one device to raise and tilt the slats.





# a splash of colour

**Venetian Uni-Blinds** are designed to match any home. With 10 colours to choose from we're certain there is one perfect for you. In addition, anthracite grey and black is exclusive to Uni-Blinds and compliments perfectly the Korniche anthracite grey and black bi-fold powder coated frames.

## slat colour

 <b>S102 WHITE*</b> Solar reflection 70% Light reflection 78% Solar absorption 30% <b>Standard colour</b>	 <b>S149 CREAM*</b> Solar reflection 68% Light reflection 75% Solar absorption 32% <b>Standard colour</b>	 <b>S157 SILVER*</b> Solar reflection 43% Light reflection 44% Solar absorption 57% <b>Standard colour</b>	 <b>S155 GREY</b> Solar reflection 42% Light reflection 48% Solar absorption 59%	 <b>S120 AGATE GREY</b> Solar Reflection 41% Light Reflection 41% Solar Absorption 59%
 <b>B160 BLACK</b> Solar reflection 4% Light reflection 4% Solar absorption 96%	 <b>S156 METALLIC SILVER</b> Solar reflection 65% Light reflection 62% Solar absorption 35%	 <b>S158 SLATE GREY</b> Solar reflection 20% Light reflection 21% Solar absorption 80%	 <b>S159 ANTHRACITE</b> Solar reflection 12% Light reflection 13% Solar absorption 88%	 <b>S159 ANTHRACITE/ S102 WHITE</b> Solar reflection 12% Light reflection 13% Solar absorption 88%
 <b>S125 BEIGE</b> Solar reflection 57% Light reflection 63% Solar absorption 43%	 <b>S142 LIGHT BLUE</b> Solar reflection 65% Light reflection 69% Solar absorption 35%	 <b>S130 GREEN</b> Solar reflection 58% Light reflection 65% Solar absorption 42%	<p><b>*When the laminated glass option is chosen the only slat colours available are S102, S149 and S157.</b></p>	

## slider, slideguide and headrail colour

 WHITE	 BEIGE	 LIGHT GREY	 ANTHRACITE GREY	 BLACK
--	--	---	--	--

\*When the laminated glass option is chosen the only slider, slide guide and headrail colours available are White, Beige and Light Grey.

## Glass

**For refurbishment & renovation projects**

Centre pane U=1.2 W/m<sup>2</sup>K  
 28mm clear low E  
 Laminated with clear low E (PAS24)

**For new build projects**

Centre pane U=1.0 W/m<sup>2</sup>K  
 Laminated with solar control

## How to operate

The **SL20SV** is operated by a cleverly-designed magnetic slider, positioned on the right or left-handed edge of glass. A narrow adhesive transparent profile ensures the linear movement of the slider. The blind is raised and lowered by moving the slider up or down and is tilted by slightly lifting or lowering the same slider.

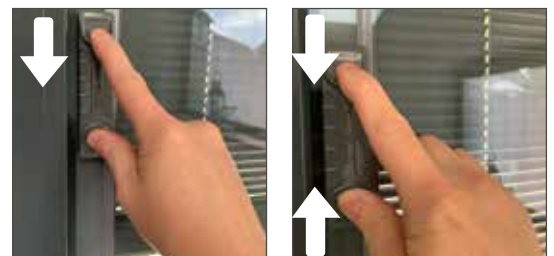
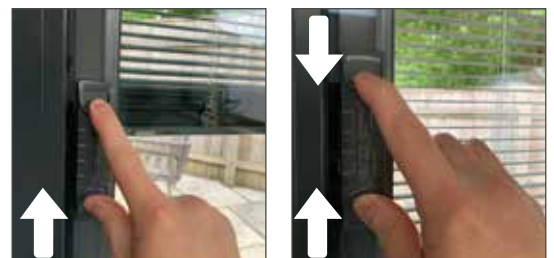



# peace of mind comes as standard with Korniche

From design to doorstep, Korniche products are engineered to deliver precision manufactured doors and lanterns for your home.



## PAS 24 Security Certified

PAS 24 Security Certified is the latest security standard that can only be achieved once a product has been tested to demonstrate enhanced protection against various types of attack. This ranges from shoulder barging and kicking to attempts to pick or damage the handle or lock. In short, it's an essential level of security for your doors.



## 10 Year Manufacturers Warranty

Engineered in the UK to ensure the highest level of quality, endurance and reliability, all Korniche products come with a 10 year warranty against all parts and manufacturing.

See T & C's on the Korniche website.



## Quality Assured

We manufacture our products to exacting tolerances, with intensive quality check and tests. As a result, we ensure your bespoke order is competitively priced and fulfilled to the highest possible standard with excellent availability and lead times.



In the unlikely event that your cylinder is snapped under attack due to a forced break-in, YALE will give you £1,000 compensation for any distress and inconvenience caused, that's how confident we are in the YALE lock barrel product. How does it work? Simply register your guarantee online at [help.yale.co.uk](http://help.yale.co.uk) within 30 days of purchase to ensure you are covered for five years.







## PAS24-2016 SECURITY

Our bi-folding doors come rigorously tested to keep your home fully protected. Certified to the advanced PAS24:2016 standard, their strong, durable aluminium frames come with enhanced security that includes a 3 Star Yale locking barrel, high strength shoot-bolts and multi-point locking systems.

The lockable shootbolt handle has an innovative and unique anti-back drive feature engineered into it. This means that even unlocked, a forced entry attempt can't rotate the handle to open the door.



# bi-folding door specification guide



# Specification and dimensions

## Slim, beautiful sightlines

- Attractive, slim-line profiles with industry leading sightlines.
- Low-profile integrated threshold as standard.
- Concealed slave lock actuator for un-cluttered aesthetics (French door arrangement).
- Slim, aluminium adjustable trickle air vents, colour matched to standard colour range.

## Fast & easy installation

- Patented clip-in internal glazing beads, the only aluminium clip-in bead which can be removed quickly without damaging the paint finish. Wedge gasket not required, cutting down on installation time.
- The door is pre-assembled and ready to glaze, easy build kit-form option.
- Pre-assembled door panels are fabricated using strong, bonded and crimped mitred corners.
- Extensive protective packaging with compartmentalised installation parts box.

## Strong and secure

- Multipoint hook locking mechanism with 'lift-up' to lock handle and adjustable, one-piece keep.
- 5 Hooks, 4 rollers and latch provide 10 locking points
- Yale 3 star kite-marked cylinder as standard.
- Anti-backdrive secondary shoot-bolt locking on folding doors with fibre reinforced guides.
- Low angle folding door shootbolt handle requiring only 120° of rotation.
- Stainless-steel fixings, rails, hardened wheels and articulated sealed rail bearings for class leading rolling smoothness and long life.

## Thermally efficient

- Wide polyamide thermal breaks and fully thermally broken profiles and locking mechanisms.
- High performance QLon, EPDM and sealed brush-pile weather seals.

## Performance

- Document L compliant
- Document F compliant
- Air permeability : class 2, 300Pa
- Water tightness : 7A
- Resistance to wind load : 1200Pa
- PAS 24:2016 enhanced security rated
- BS 6375 compliant
- Passed 50,000 traffic door + 5000 folding cycles
- DSER C Rated (Renovation / Replacement)\*

\* DSER or Door Set Energy Rating is a calculation of heat loss, solar gain, and the amount of air leakage which results in a rating letter. Compliance with building regs is achieved by a C rating for Renovation/ Replacement projects.

## Dimensions

- Frame depth 84mm
- Sash depth 75mm
- Glass 28mm double glazed units
- Max sash height : 2500mm
- Max frame height\* : 2559mm (including integrated threshold)
- Max frame height\* : 2563mm (including std threshold not including any cill)
- Max width 1250mm (per sash)
- Max sash weight : 120kg

\* Frame heights can be increase by 20 or 40mm over the dimensions above by adding a frame extender to the top. An additional 16.25mm with cill and standard threshold



## Glass

### Options to suit all projects

#### Renovation / replacement options:

1. 28mm low E Toughened
2. 28.8 mm low E Laminated (P1A)

#### New build options:

1. 28.8 mm Performance low E Laminated (P1A)

All Glass can be specified with or without integral blinds



## Compliance



New build certification sticker applied to door casement



Refurbishment certification sticker applied to door casement

Korniche Bi-folding doors are factory certified, compliant with building regulations when purchased with glazing

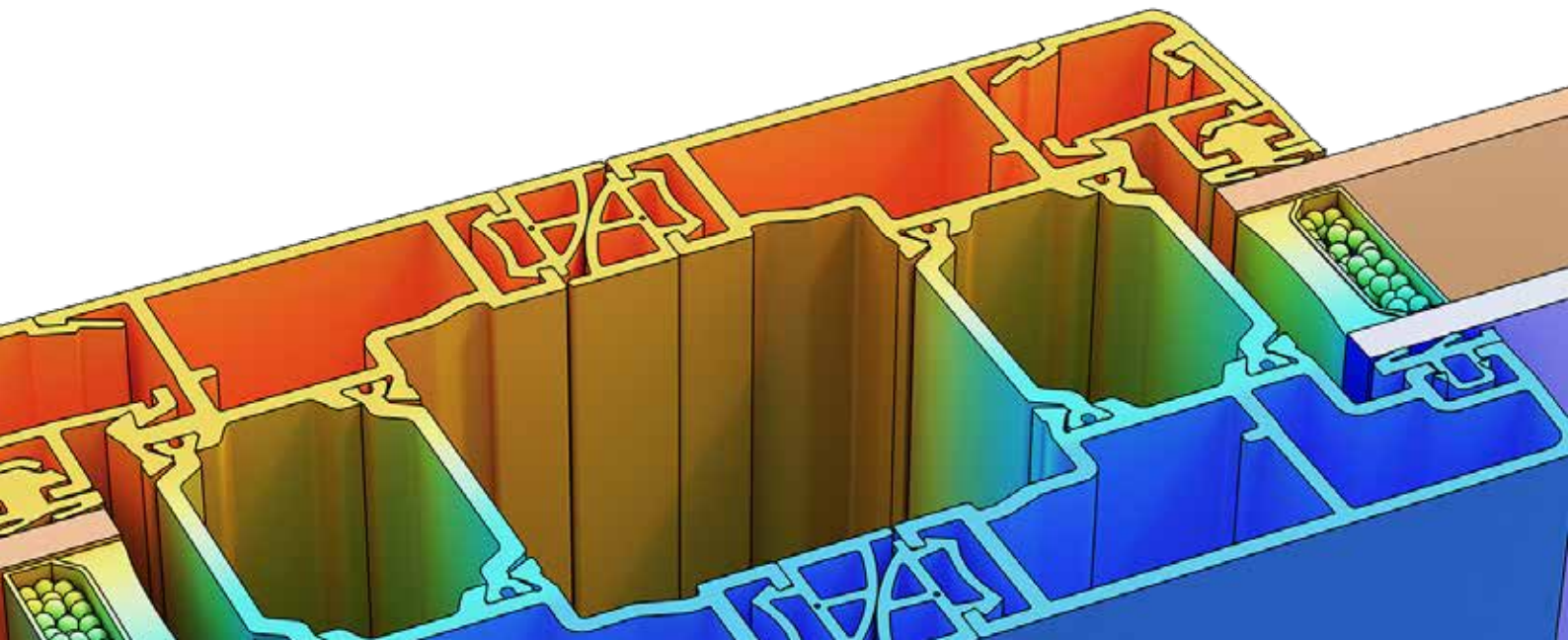

## Configuration options

- Available in any BS or RAL colours
- Doors up to 6.4m wide
- Height up to 2.5m
- Each sash up to 1.25m wide
- 1-7 sashes
- Multiple configurations
- Doors open in or out

Next to each configuration diagram, you will see a number that indicates its opening options (e.g. 4-3-1).

The first number refers to how many door sashes are included within the set.

The second number indicates how many of those doors open to the left, with the final number representing the doors that open to the right.

The doors that feature traffic handles (standard door handles) are master doors which provide both internal and external access.

Shootbolt handles (indicated as a single vertical line) allow the sliding door sashes to be locked in place from the inside only. Door configurations that have just a shootbolt handle do not provide any external access.

### Single door

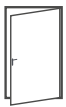

1-0-1



1-1-0

### Two door

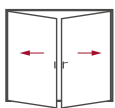

2-1-1

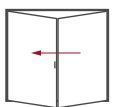

2-2-0



2-0-2

### Three door

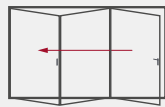

3-3-0

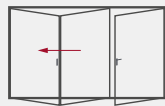

3-2-1

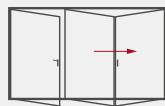

3-1-2

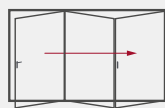

3-0-3

### Four door

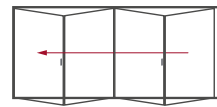

4-4-0

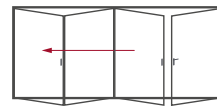

4-3-1

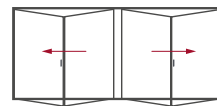

4-2-2

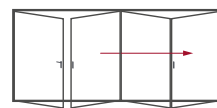

4-1-3

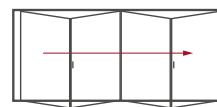

4-0-4

### KEY

 - Traffic handle

 - Shootbolt handle



Five door

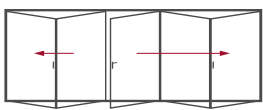

5-2-3

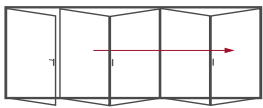

5-1-4

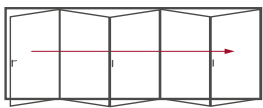

5-0-5

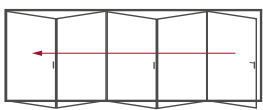

5-5-0

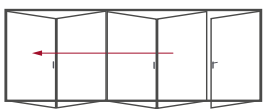

5-4-1

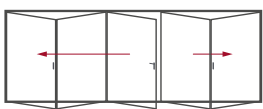

5-3-2

Six door

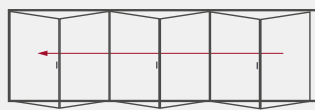

6-6-0

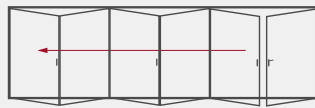

6-5-1

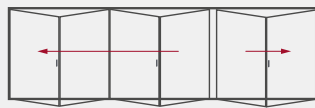

6-4-2

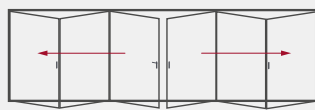

6-3-3

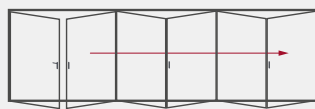

6-1-5

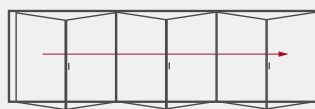

6-0-6

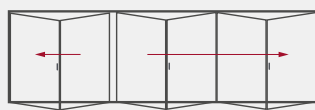

6-2-4

Seven door

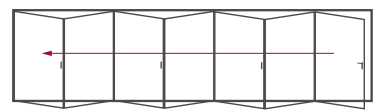

7-7-0

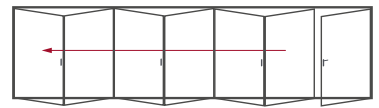

7-6-1

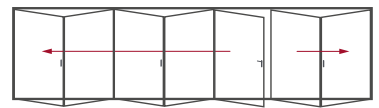

7-5-2

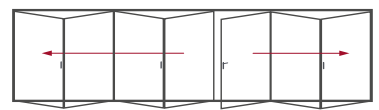

7-4-3

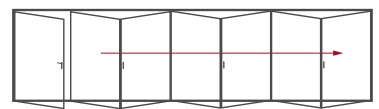

7-1-6

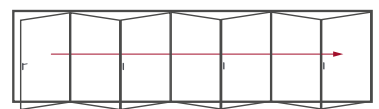

7-0-7

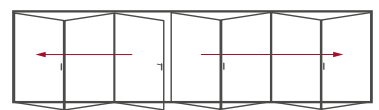

7-3-4

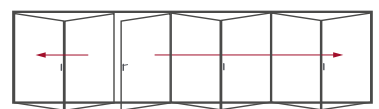

7-2-5

# Hardware



Matching optional trickle vents



Top roller hinge



Main hinge



Anti-lift security keel feature

Top mullion roller

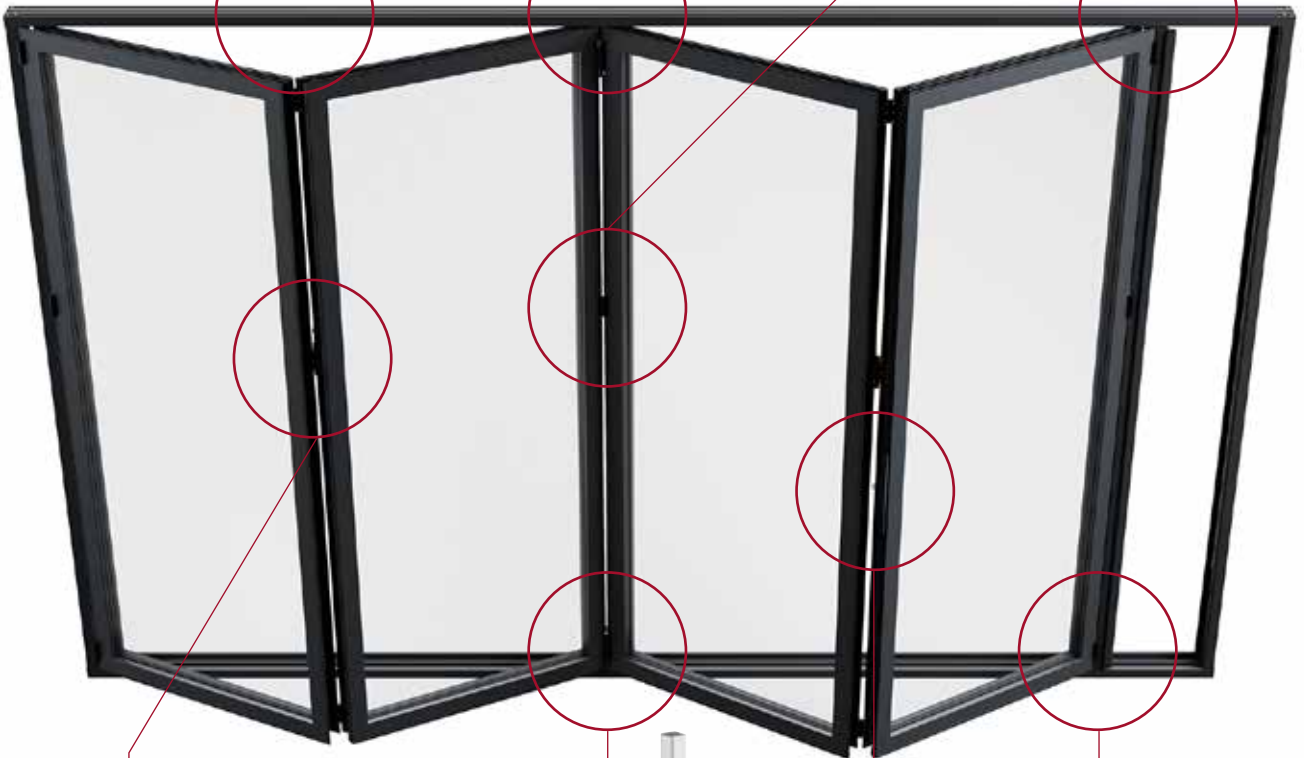

D-handle hinge



Bottom roller hinge



Shoot bolt handle, key + gearbox

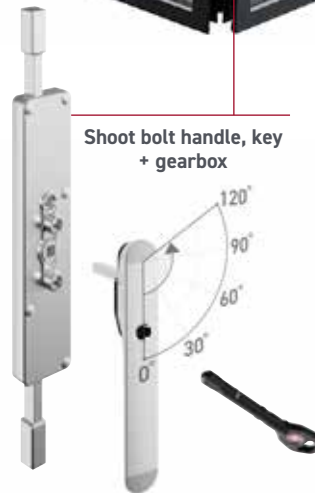

Only 120° to open

Bottom mullion roller







# Hardware

One piece, full length 10 point lock & keep features

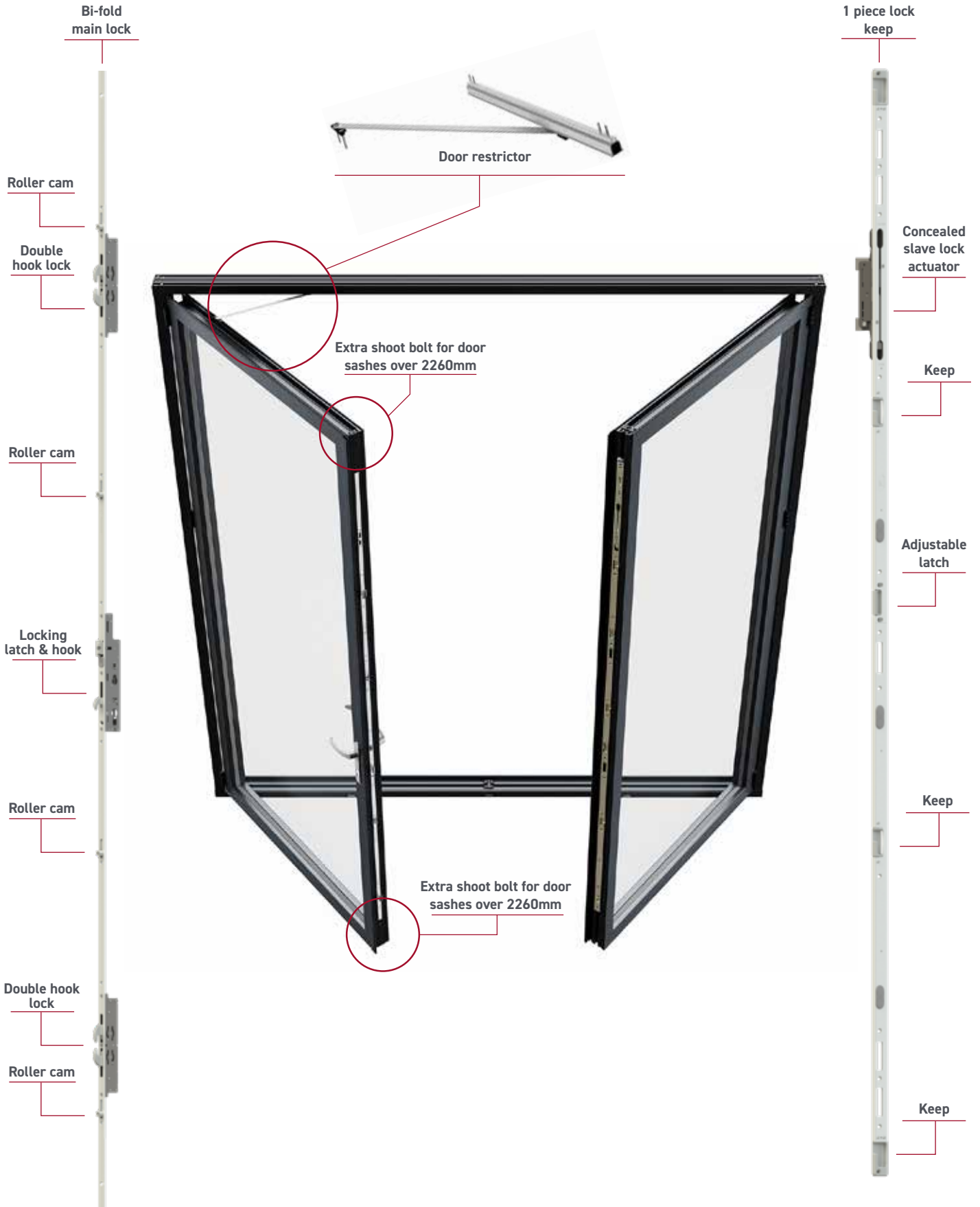

## Components



Folding door shootbolt key



Yale 3 star locking barrel

Yale 3 star key



Magnetic catch



Matching adjustable aluminium trickle vent - 2667mm<sup>2</sup> per vent



High strength traffic door restrictor mechanism

## Survey guide

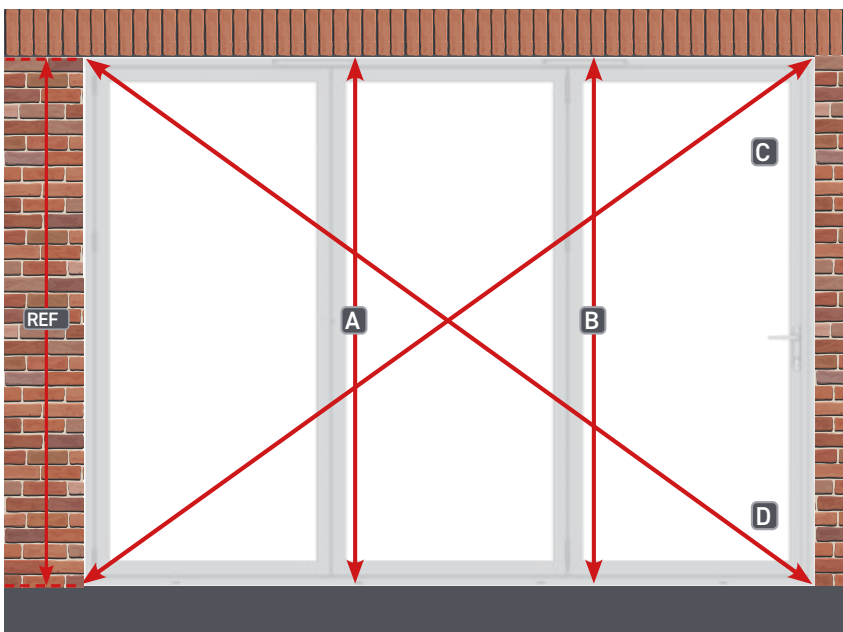

$$\begin{aligned} \text{REF} &= \text{A} = \text{B} \pm 2\text{mm} \\ \text{C} &= \text{D} \pm 2\text{mm} \end{aligned}$$

Allow 10mm clearance to wall on height and width, opening must be square, observe above checking dimensions.

# BI-FOLDING DOOR PROFILE INFORMATION

## Dimensions

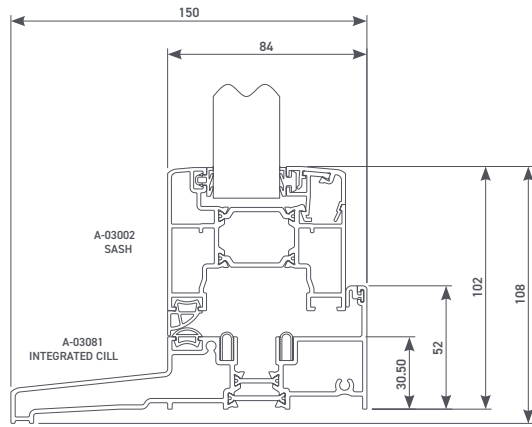

Integrated cill with sash profile

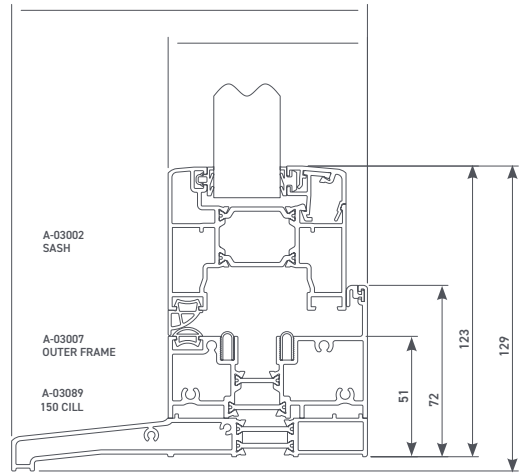

150mm cill with outer frame & sash profile

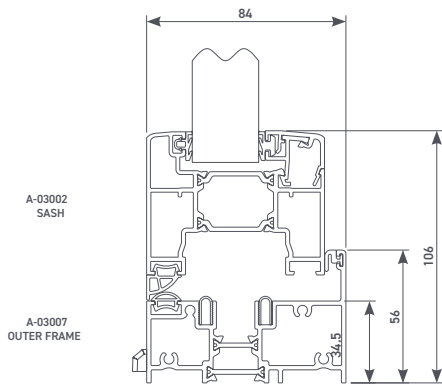

Standard outer frame with face drain

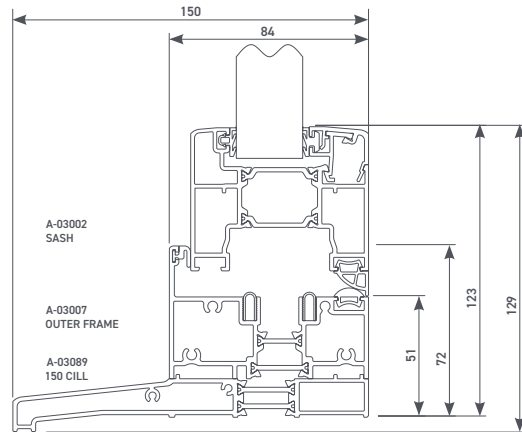

150mm cill with outer frame & sash profile - Open in

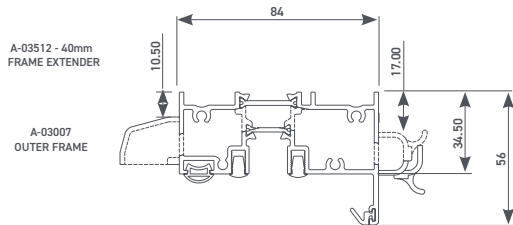

Standard open out outer frame with trickle vent

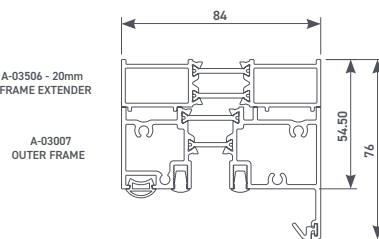

Standard outer frame with 20mm extender

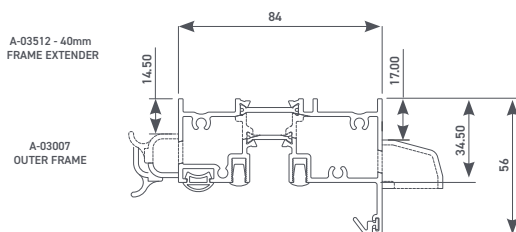

Standard open in outer frame with trickle vent

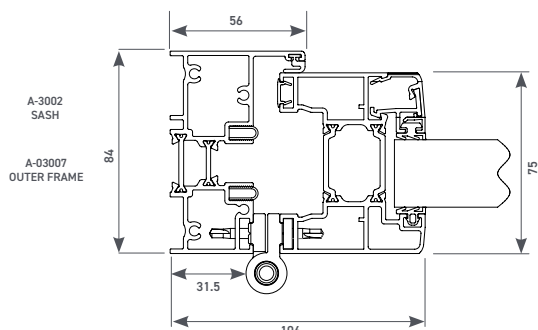

Outer frame and sash profile with hinge

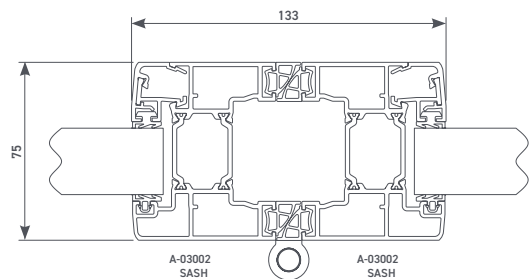

Sash to sash

# BI-FOLDING DOOR PROFILE INFORMATION

## Dimensions

Traffic door connecting to sliding mullion

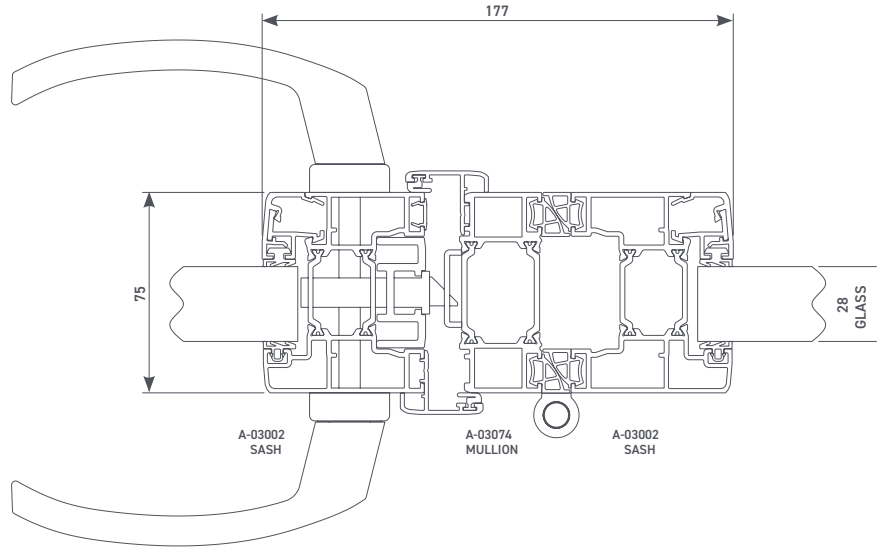

Traffic door to slave door (french door arrangement)

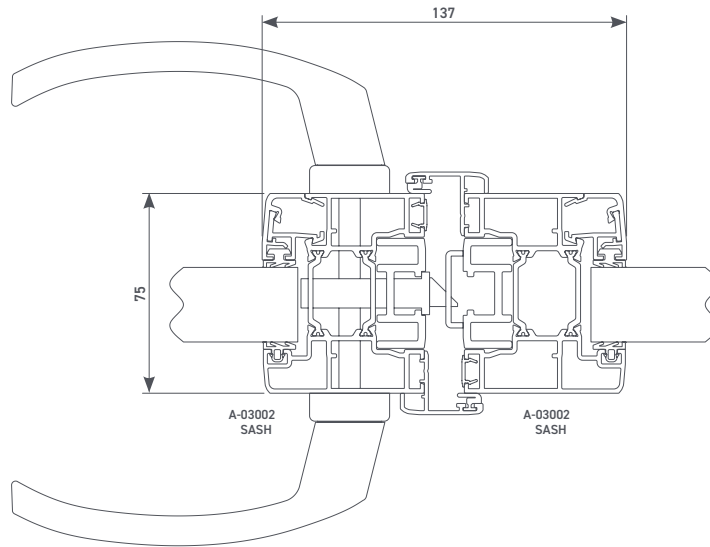

Traffic door to outer frame

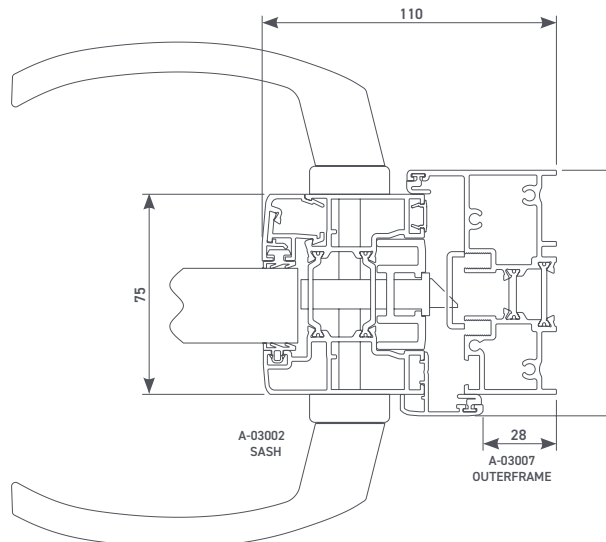

# BI-FOLDING DOOR PROFILE INFORMATION

## Dimensions

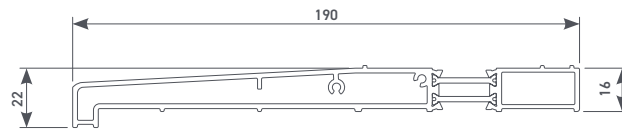
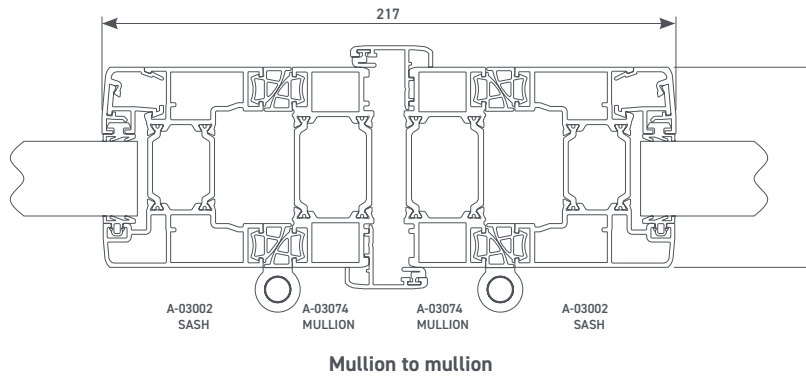

**A-03090 - 190mm cill**

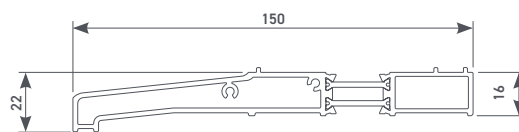

**A-03089 - 150mm cill**

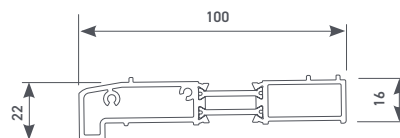

**A-03088 - 100mm cill**

# multi-award-winning products recognised across the industry



The Korniche aluminium product range, has received multiple awards for its innovative design, engineering and aesthetics, including both builder and homeowner accreditation.

- ▀ The King's Award for Innovation 2024
- ▀ NFA Awards Finalist, 2024
- ▀ NFA Awards Winner, 2021, 2022, 2023
- ▀ Build-It Awards 2022
- ▀ Manufacturing ISO9001:2015 Quality accreditation 2022



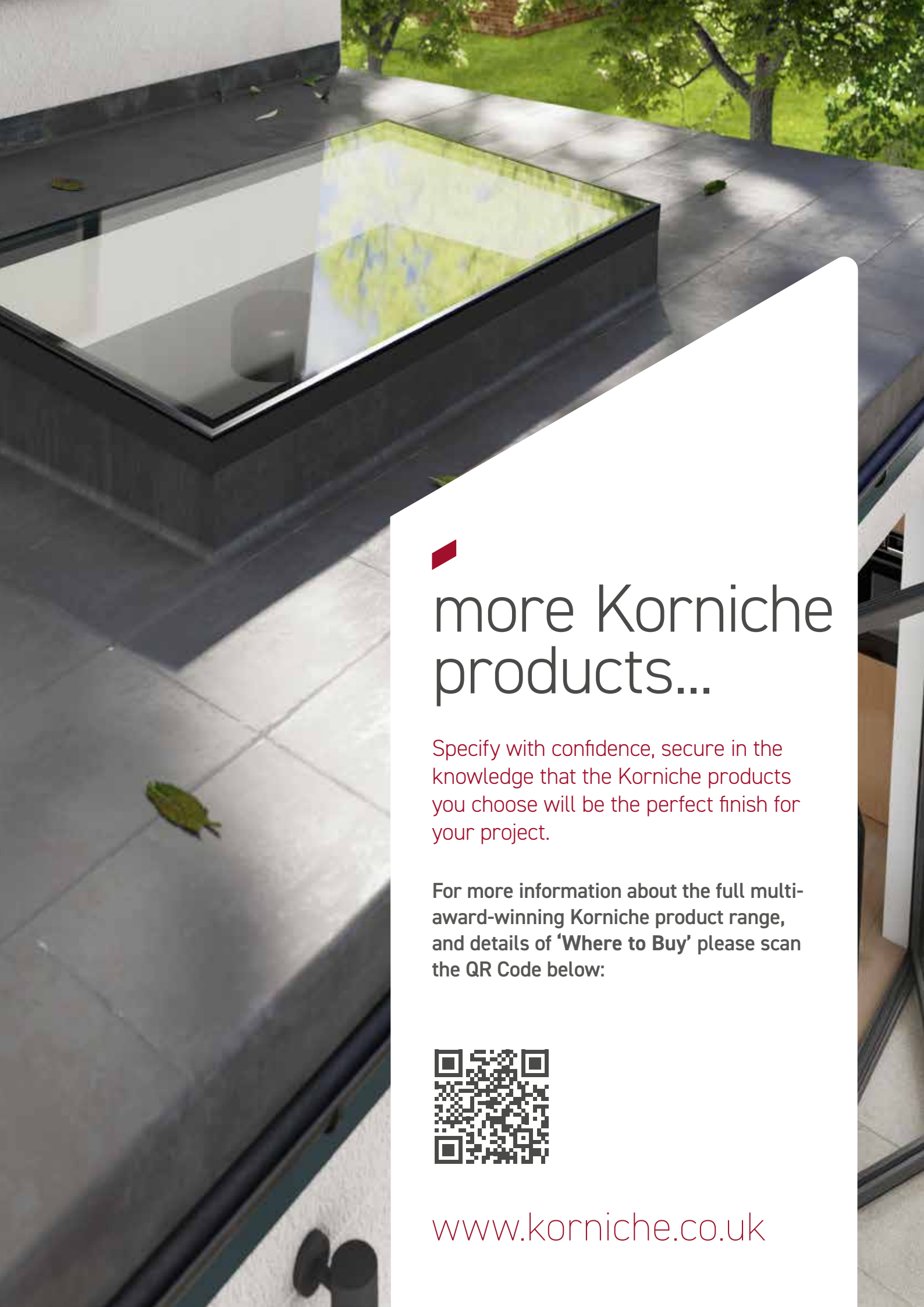

# more Korniche products...

Specify with confidence, secure in the knowledge that the Korniche products you choose will be the perfect finish for your project.

For more information about the full multi-award-winning Korniche product range, and details of 'Where to Buy' please scan the QR Code below:

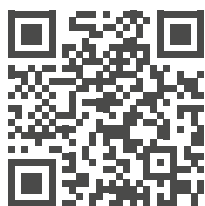

[www.korniche.co.uk](http://www.korniche.co.uk)



transform  
your space  
with **Korniche**



[www.korniche.co.uk](http://www.korniche.co.uk)

